



engineered sound®



Thank you for purchasing this product. Before using the product, read through the user manual to ensure that you will use the product correctly. Please keep this manual for future reference.

Features

- Designed for surface-mount applications such as conferencing, recording, monitoring and other demanding sound pickup applications
- Low-profile element provides uniform omnidirectional polar pattern with 360° acceptance angle
- Mounts unobtrusively in tabletops, ceilings and panels
- IPX4 water resistance protects the microphone from splashes of water
- Self-contained power module with XLRM-type output connector
- Rugged all-metal case with a two-layer perforated grille
- Rubber Isolators provide mechanical dampening of mounting-surface vibration
- Requires 11V to 52V DC phantom power
- UniGuard® RFI-shielding technology offers outstanding rejection of radio frequency interference (RFI)

Description

With its low-profile design that mounts unobtrusively in tabletops, ceilings or panels for minimum visibility, the ES9450/XLR omnidirectional condenser boundary microphone provides clear, highly intelligible audio that is perfect for conferencing, recording, monitoring and other demanding sound pickup applications.

Protected by a rugged all-metal case with a two-layer perforated grille, the microphone's omnidirectional polar pattern affords a 360° pickup angle, while its UniGuard® RFI-shielding technology provides outstanding rejection of radio frequency interference (RFI). The microphone also offers IPX4 water resistance to protect it from splashes of water.

The ES9450/XLR is equipped with a self-contained power module with an XLRM-type output connector, eliminating the need for an external power module. The integral power module can be powered from any external 11V to 52V DC phantom power supply.

The microphone is black colour, and comes with a pair of rubber isolators for optional mechanical isolation from the mounting surface.

Avoid leaving the microphone in the open sun or in areas where temperatures exceed 43°C for extended periods. Extremely high humidity should also be avoided.

Safety precaution

Although this product was designed to be used safely, failing to use it correctly may result in an accident. To ensure safety, observe all warnings and cautions while using the product.

Cautions for the product

- Do not subject the product to strong impact to avoid malfunction.
- Do not disassemble, modify or attempt to repair the product.
- Do not handle the product with wet hands to avoid electric shock or injury.
- Do not store the product under direct sunlight, near heating devices or in a hot, humid or dusty place.

Connection procedure

Connect the output terminals of the microphone to a device that has a microphone input (balanced input) compatible with a phantom power supply. The output connector is an XLRM-type with polarity as shown in the figure below.

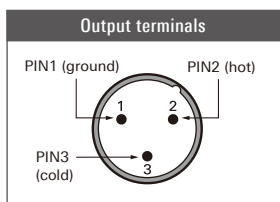

This product requires 48 V DC phantom power.

Specifications

Element	Fixed-charge back plate, permanently polarized condenser
Polar pattern	Omnidirectional
Frequency response	60 - 15,000 Hz
Open circuit sensitivity	-33 dB re 1V at 1 Pa
Impedance	100 ohms
Maximum input sound level	130 dB SPL (1 kHz at 1% THD)
Dynamic range (typical)	109 dB (1 kHz at Max SPL)
Signal-to-noise ratio*	73 dB (1 kHz at 1 Pa, A-weighted)
Phantom power requirements	11-52 V DC, 2 mA
Weight	62 g
Dimensions	28 mm head diameter, 69 mm long
Output connector	Integral 3-pin XLRM-type
Included accessories	Rubber isolator x 2, Nut
Colour	Black

* 1 Pascal = 10 dynes/cm² = 10 microbars = 94 dB SPL

* Typical, A-weighted, using Audio Precision System One.

For product improvement, the product is subject to modification without notice.

Polar pattern

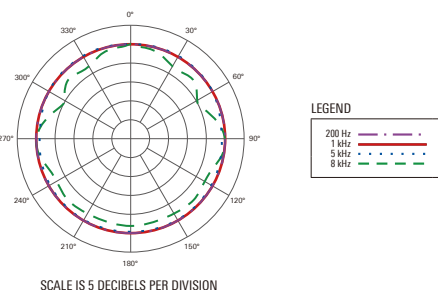

Frequency response

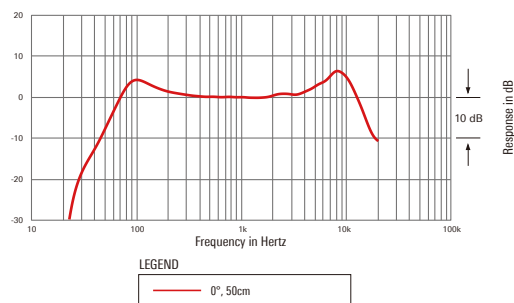

Dimensions

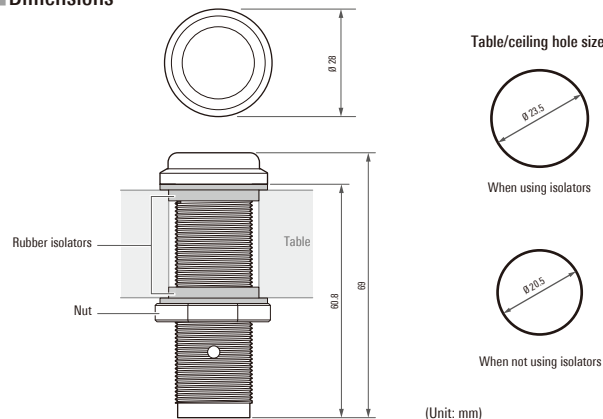

Audio-Technica Corporation
2-46-1 Nishi-naruse, Machida, Tokyo 194-8666, Japan
©2017 Audio-Technica Corporation

Global Support Contact: www.at-globalsupport.com



engineered sound®



感谢您购买本产品。在使用产品之前，请全文浏览本用户手册以确保您将正确地使用本产品。请妥善保存本手册，以供将来参考。

■ 特点

- 专为会议、录音、监听和其他要求苛刻的收音应用等表面安装应用而设计
- 薄型元件提供均匀的全方向指向性，收音角度为360°
- 能牢固地安装在桌面、天花板和控制面板上
- IPX4 防水级别可防止话筒被溅水
- 带 XLRM 型输出连接器的独立内置式供电模块
- 坚固的全金属外壳，配有两层穿孔保护网格
- 橡胶防震片可阻隔安装表面的机械式振动
- 使用 11V 至 52V 直流幻像电源
- UniGuard® RFI 屏蔽技术可有效地抑制射频干扰

■ 说明

ES9450/XLR 全指向性电容式界面话筒采用不显眼设计，可以毫不费力地安装在桌面、天花板或控制面板上，以提供最佳的隐蔽性，可作清晰而通透的收音，非常适合会议、录音、监听和其他要求苛刻的收音应用。

话筒采用坚固的全金属外壳和两层穿孔保护网格，其全指向性模式提供了360°的收音角度，而话筒配有 UniGuard® RFI 屏蔽技术可以有效地抑制射频干扰。ES9450/XLR 还具有 IPX4 防水功能，可防止被水溅进内部。

ES9450/XLR 配备了带有 XLRM 型输出连接器的独立供电模组，从而无需外部电源元件，供电模组使用直流 11V 至 52V 幻象供电。

话筒为黑色外观，并配有一对橡胶防震垫片，用于可阻隔安装表面的机械式振动。

把话筒暴露于高温中可能导致输出电平逐渐及永久性减弱，应避免将话筒留在日晒的地方或长时间置于温度超过43°C的地方，而极高湿度也应避免。

■ 安全预防措施

虽然本产品采用安全设计，但使用不当仍可能发生事故。为了确保安全，使用本产品时请注意全部警告和提醒。

■ 本产品注意事项

- 设切勿让本产品遭受强烈冲击，以避免发生故障。
- 屏切勿拆开、改装或尝试维修本产品。
- 独切勿用湿手握持本产品，以免触电或受伤。
- 小切勿将本产品存放在阳光直射的地方、加热装置附近或者炎热、潮湿或多尘的地方。

■ 连接步骤

将话筒的输出端子连接到具有兼容幻象电源的话筒输入（平衡输入）的设备。输出接口是 XLRM 型接口，其极性如下图所示。

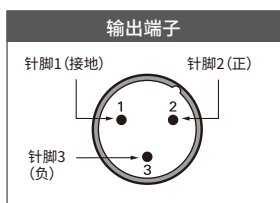

本产品使用直流 48V 幻象电源。

■ 规格

元件	固定充电背板,永久极化电容体
指向性	全指向性
频率响应	60 - 15,000 Hz
开路灵敏度	-33 dB (0dB = 1V/Pa, 1kHz)
阻抗	100 欧姆
最大输入声压级	130 dB SPL (1kHz 于 1% THD)
动态范围 (典型)	109 dB (1kHz 于最大声压级)
信噪比*	73 dB (1kHz于1Pa, A计权)
幻象供电	直流 11-52V, 2mA 典型
重量	62 克
尺寸	长 69 毫米, 收音头直径 28 毫米
输出接口	内置 XLRM-3 针卡农公头
附带配件	橡胶防震垫片 x 2, 螺母
颜色	黑色

* 1 帕 = 10 达因 / 平方厘米 = 10 微巴 = 94 dB SPL

* 典型, A 计权, 使用 Audio Precision System One

因产品改进, 本产品会随时改装, 恕不另行通知。

■ 指向性

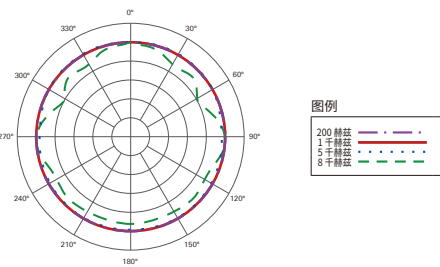

■ 频率响应

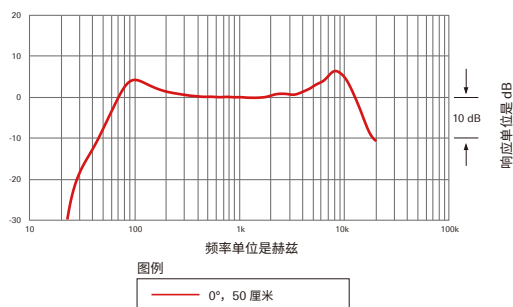

■ 尺寸

